

**Türzubehör**

Türbänder VX	6.02-9
Wand-Türpuffer	6.03-9
Boden-Türpuffer	6.04-9
Zahlen und Buchstaben	6.05-9
Türfunktionsschilder	6.06-9

**Accessories**

Hinges VX	6.02-9
Wall mounted door stops	6.03-9
Floor mounted door stops	6.04-9
Numbers and letters	6.05-9
Push/pull symbols	6.06-9

**Kurzzeichen Türbänder VX**

**ER**      Edelstahl Rostfrei  
**TB**      Türband

**Identification hinges VX**

**ER**      Stainless steel  
**TB**      Hinge

**Bestellnummern-System**

**Explanation of product code**

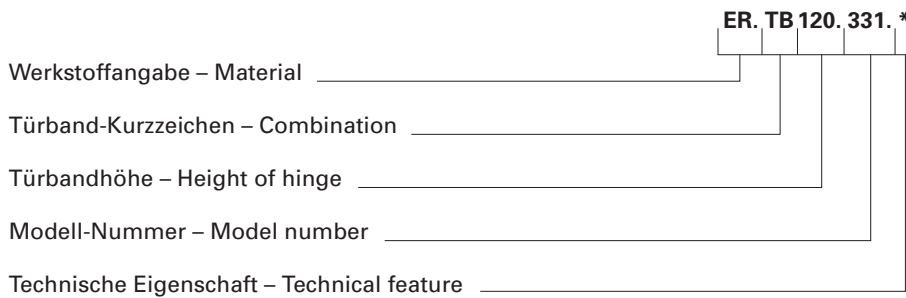

\* **S** = stumpf  
**F** = überfäلت  
**SI** = Sicherung  
**T** = Tragbolzen

\* **S** = standard  
**F** = rebated  
**SI** = security screw  
**T** = carrying bolts

**Modellübersicht Türbänder VX – Edelstahl**

**Vieler hinges VX – stainless steel**

VX 120 S

6.02-9

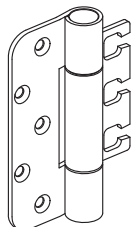

VX 120 F

6.02-9

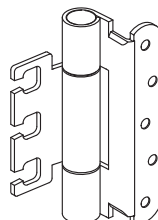

VX 160 S

6.02-9

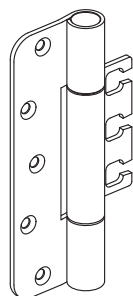

VX 160 F

6.02-9

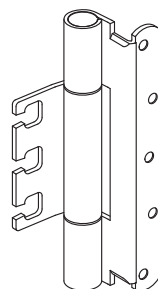



**Vieler Türbänder VX – Edelstahl**  
**Vieler hinges VX – stainless steel**

● = Bandbezugslinie  
= Centre line for installation

**Türband VX 120 S**

Für stumpfe Türen, optional mit Stiftsicherung und Tragbolzen. Je ein mittiger Tragbolzen Ø 12 mm, 60 mm lang, pro Band. Senkbohrungen Ø 6 / Ø 10,5 mm x 90° für Senkholzschrauben Ø 5 x 50 mm. Zulässiges Türgewicht 160 kg, Referenz für 2 Türbänder.



**Hinge VX 120 S**

For standard doors, with or without protection screw and carrying bolts. One carrying bolt each hinge, centrally, Ø 12 mm, length 60 mm, drillings Ø 6 / Ø 10,5 mm x 90° for wood screws Ø 5 x 50 mm. Max door weight 160 kg, (2 hinges each door)

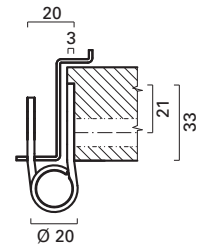
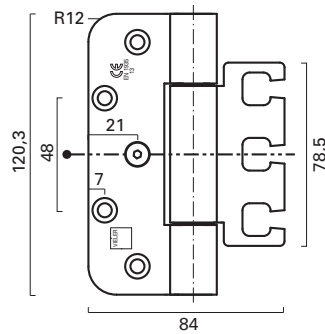

STRIMA  
Frässhablone 11813504  
template 11813504

**Türband VX 120 F**

Für gefälzte Türen, optional mit Stiftsicherung und Tragbolzen. Je ein mittiger Tragbolzen Ø 12 mm, 60 mm lang, pro Band. Senkbohrungen Ø 6 / Ø 10,5 mm x 90° für Senkholzschrauben Ø 5 x 50 mm. Zulässiges Türgewicht 160 kg, Referenz für 2 Türbänder.



**Hinge VX 120 F**

For rebated doors, with or without protection screw and carrying bolts. One carrying bolt each hinge, centrally, Ø 12 mm, length 60 mm, drillings Ø 6 / Ø 10,5 mm x 90° for wood screws Ø 5 x 50 mm. Max door weight 160 kg, (2 hinges each door)

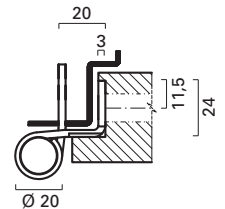
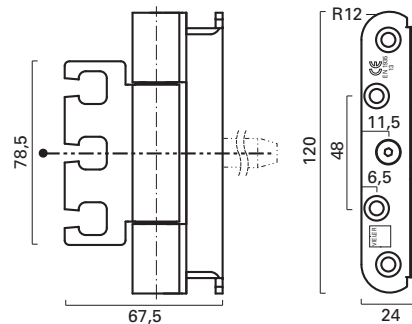

STRIMA  
Frässhablone 11813501  
template 11813501

**Türband VX 160 S**

Für stumpfe Türen, optional mit Stiftsicherung und Tragbolzen. Je ein mittiger Tragbolzen Ø 12 mm, 60 mm lang, pro Band. Senkbohrungen Ø 6 / Ø 10,5 mm x 90° für Senkholzschrauben Ø 5 x 50 mm. Zulässiges Türgewicht 260 kg, Referenz für 2 Türbänder.



**Hinge VX 160 S**

For standard doors, with or without protection screw and carrying bolts. One carrying bolt each hinge, centrally, Ø 12 mm, length 60 mm, drillings Ø 6 / Ø 10,5 mm x 90° for wood screws Ø 5 x 50 mm. Max door weight 260 kg, (2 hinges each door)

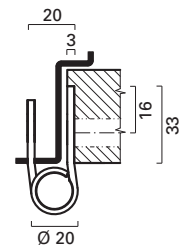
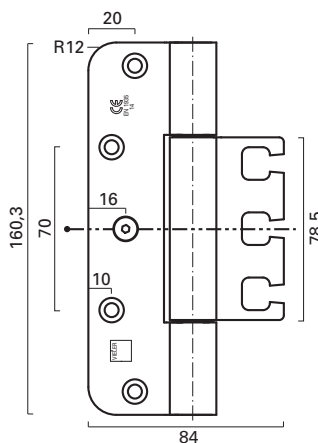

STRIMA  
Frässhablone 11813512  
template 11813512

**Türband VX 160 F**

Für gefälzte Türen, optional mit Stiftsicherung und Tragbolzen. Je ein mittiger Tragbolzen Ø 12 mm, 60 mm lang, pro Band. Senkbohrungen Ø 6 / Ø 10,5 mm x 90° für Senkholzschrauben Ø 5 x 50 mm. Zulässiges Türgewicht 260 kg, Referenz für 2 Türbänder.



**Hinge VX 160 F**

For rebated doors, with or without protection screw and carrying bolts. One carrying bolt each hinge, centrally, Ø 12 mm, length 60 mm, drillings Ø 6 / Ø 10,5 mm x 90° for wood screws Ø 5 x 50 mm. Max door weight 260 kg, (2 hinges each door)

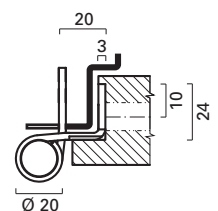
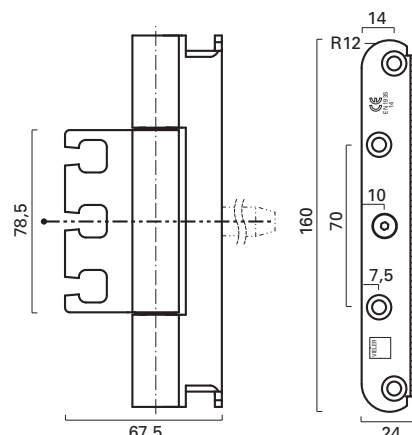

STRIMA  
Frässhablone 11813524  
template 11813524

Bezugsquelle Frässhablonen:  
Source of supply templates:

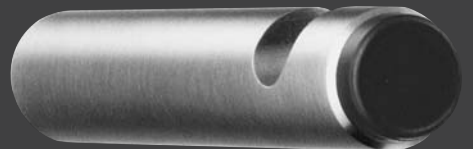
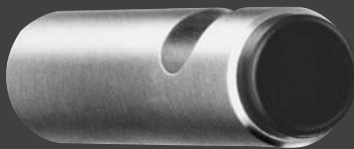
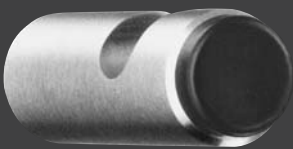
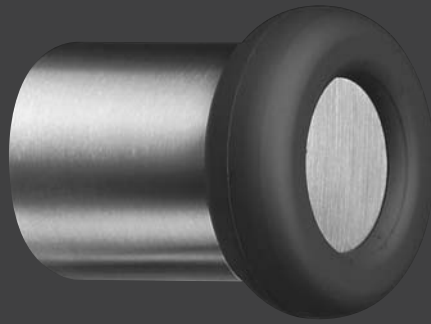

**Vieler Wand-Türpuffer – Edelstahl**

Hochwertiges Material mit matt gebürsteter, pflegeleichter Oberfläche. Gummi schwarz.

**Vieler wall mounted door stops – stainless steel**

Maintenance free brushed satin stainless steel. Black rubber.

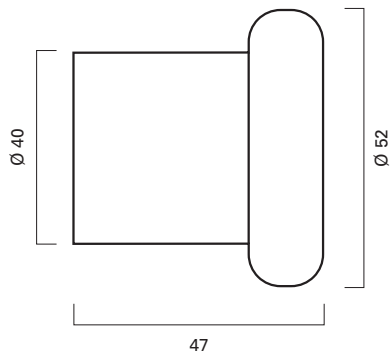

**ER.TP.5121**

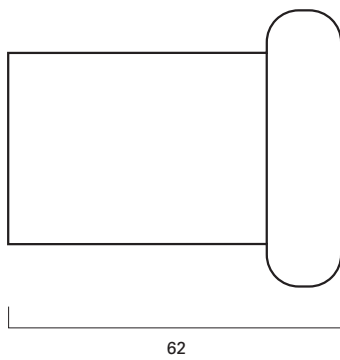

**ER.TP.5122**

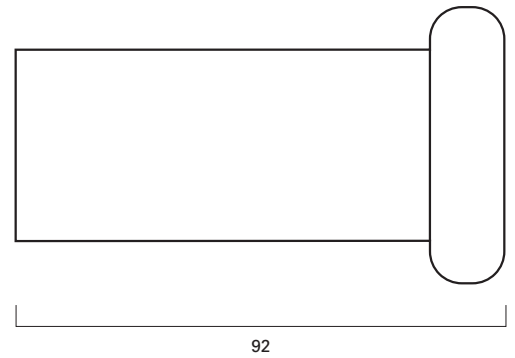

**ER.TP.5123**

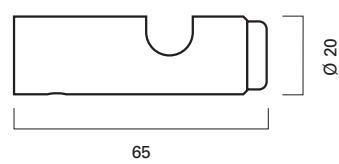

**ER.TP.6533**

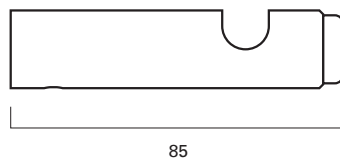

**ER.TP.6537**

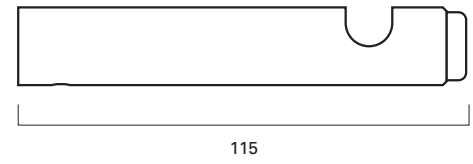

**ER.TP.6538**

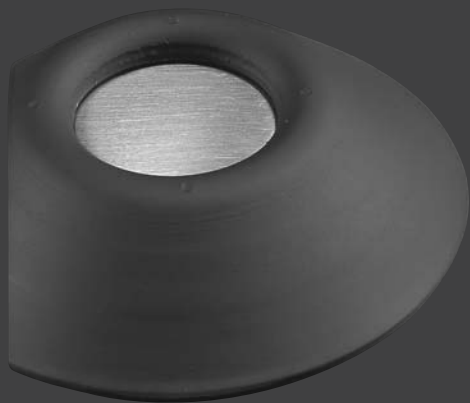

**Vieler Boden-Türpuffer – Edelstahl**

Hochwertiges Material mit matt gebürsteter, pflegeleichter Oberfläche. Gummi schwarz.

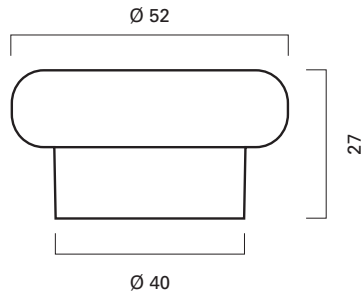

**ER.TP.5120**

**Vieler floor mounted door stops – stainless steel**

Maintenance free brushed satin stainless steel. Black rubber.

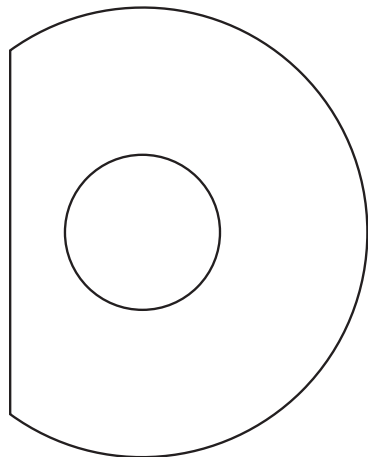
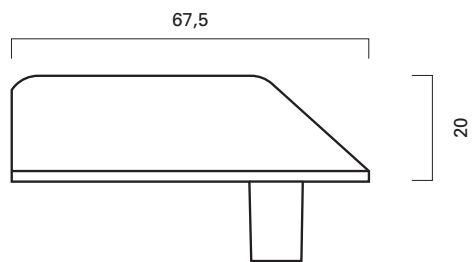

**ER.TP.5103**

17

a

**Vieler Zahlen und Buchstaben – Edelstahl**

Hochwertiges Material mit matt gebürsteter, pflegeleichter Oberfläche. Schriftgröße 150 und 200 mm.

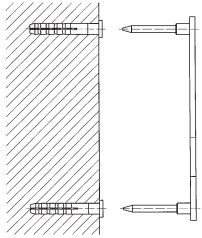

**Vieler numbers and letters – stainless steel**

Maintenance free brushed satin stainless steel. Type size 150 and 200 mm.

1 150 ER.HN150.1  
200 ER.HN200.1

2 150 ER.HN150.2  
200 ER.HN200.2

3 150 ER.HN150.3  
200 ER.HN200.3

4 150 ER.HN150.4  
200 ER.HN200.4

5 150 ER.HN150.5  
200 ER.HN200.5

6 150 ER.HN150.6  
200 ER.HN200.6

7 150 ER.HN150.7  
200 ER.HN200.7

8 150 ER.HN150.8  
200 ER.HN200.8

9 150 ER.HN150.9  
200 ER.HN200.9

0 150 ER.HN150.0  
200 ER.HN200.0

/ 150 ER.HN150.11  
200 ER.HN200.11

□ 150 ER.HN150.12  
200 ER.HN200.12

□ 150 ER.HN150.13  
200 ER.HN200.13

a 150 ER.KB150.A  
200 ER.KB200.A

b 150 ER.KB150.B  
200 ER.KB200.B

c 150 ER.KB150.C  
200 ER.KB200.C

d 150 ER.KB150.D  
200 ER.KB200.D

e 150 ER.KB150.E  
200 ER.KB200.E

A 150 ER.GB150.A  
200 ER.GB200.A

B 150 ER.GB150.B  
200 ER.GB200.B

C 150 ER.GB150.C  
200 ER.GB200.C

D 150 ER.GB150.D  
200 ER.GB200.D

E 150 ER.GB150.E  
200 ER.GB200.E



**Vieler Türfunktionsschilder – Edelstahl**

Hochwertiges Material, 1 mm dick, mit matt gebürsteter, pflegeleichter Oberfläche, selbstklebend.



**ER.TF.0630**

**Vieler push/pull symbols – stainless steel**

Maintenance free brushed satin stainless steel. 1 mm thick, self-adhesive.



**ER.TF.0631**

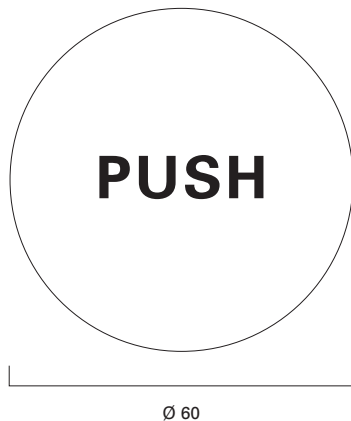

**ER.TF.0632**

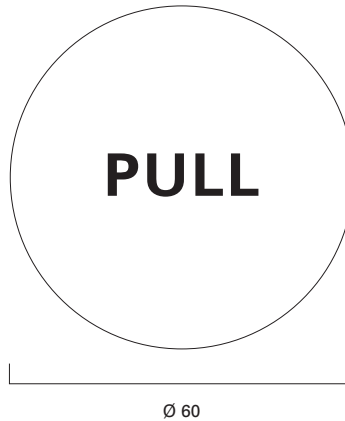

**ER.TF.0633**